

BANDRASTER

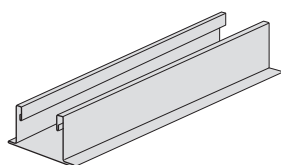

Bandraster is a suspension system available in a wide range of widths, compatible with Prelude 24 TLX/XL² Cross Tees.

Bandraster Systems

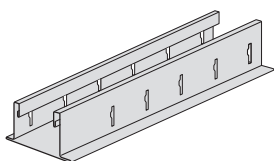
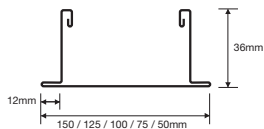

Item Nr.	Dimensions length (mm) Height (mm)		Content / Carton pcs	lm	Weight / Carton kg	Cartons / Pallet
----------	---------------------------------------	--	-------------------------	----	-----------------------	------------------

Slotted at 312,50 mm (1)

36 2100 B	3750	100	8	30,00	32,60	16
-----------	------	-----	---	-------	-------	----

Slotted at 100 mm (1)

36 3050	3600	50	8	28,80	24,00	28
36 3075	3600	75	8	28,80	27,70	20
36 3100*	3600	100	8	28,80	31,40	16
36 3125	3600	125	8	28,80	38,30	12
36 3150	3600	150	4	14,40	21,20	20

Unslotted (2)

36 0050 A	3600	50	8	28,80	24,00	28
36 0075 A*	3600	75	8	28,80	27,70	20
36 0100 A	3600	100	8	28,80	31,40	16
36 0125 A	3600	125	8	28,80	38,30	12
36 0150	3600	150	4	14,40	21,20	20

(1) Is compatible with all plank edge details whether cross tees are required or not.

(2) Is compatible with only with plank edge details when no visible cross tees span between bandraster sections.

Bandraster Accessories

Item Nr.	Description	Dimension height (mm)	Content / Carton pcs	Weight / Carton kg
----------	-------------	--------------------------	-------------------------	-----------------------

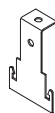

A 36 0501	Strip / rod connector	50	50	1,20
A 36 0751		75	50	1,50
A 36 1001		100	50	1,80

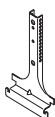

A 36 0502 G	Nonius hanger	50	100	5,80
A 36 0752 G		75	100	8,10
A 36 1002 G		100	100	11,00
A 36 1252 G		125	100	12,50
A 36 1502 G		150	100	15,00

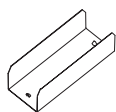

A 36 0503 G	Splice	50	100	8,00
A 36 0753 G		75	100	8,30
A 36 1003 G		100	100	14,00
A 36 1253 G		125	100	17,00
A 36 1503 G		150	100	19,50

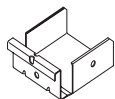

A 36 0504 G	Cross connector	50	100	5,80
A 36 0754 G		75	100	8,10
A 36 1004 G		100	100	11,00
A 36 1254 G		125	100	12,50
A 36 1504 G		150	50	7,50

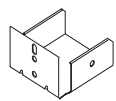

A 36 0505 G	Wall connector	50	100	5,80
A 36 0755 G		75	100	8,10
A 36 1005 G		100	100	11,00
A 36 1255 G		125	100	12,50
A 36 1505 G		150	50	7,50

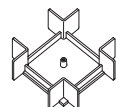

A 36 0506 G	Crossing element	50	48	7,70
A 36 0756 G		75	30	5,70
A 36 1006 G		100	32	7,40

Product available as standard in Global White.

*Also available in RAL 9010 (WR)

All measurements in millimetres. All sizes are nominal.

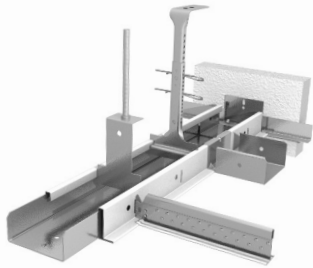

BANDRASTER

System Drawing

- Slotted Bandraster is compatible either with Prelude 24 XL² or Prelude 24 TLX Cross Tees
- On special request: Prelude 15 TL can be made compatible for installation with slotted Bandraster;
- Special spaced slotting; minimum slot spacing is 50 mm; Maximum length of Bandraster is 5000 mm

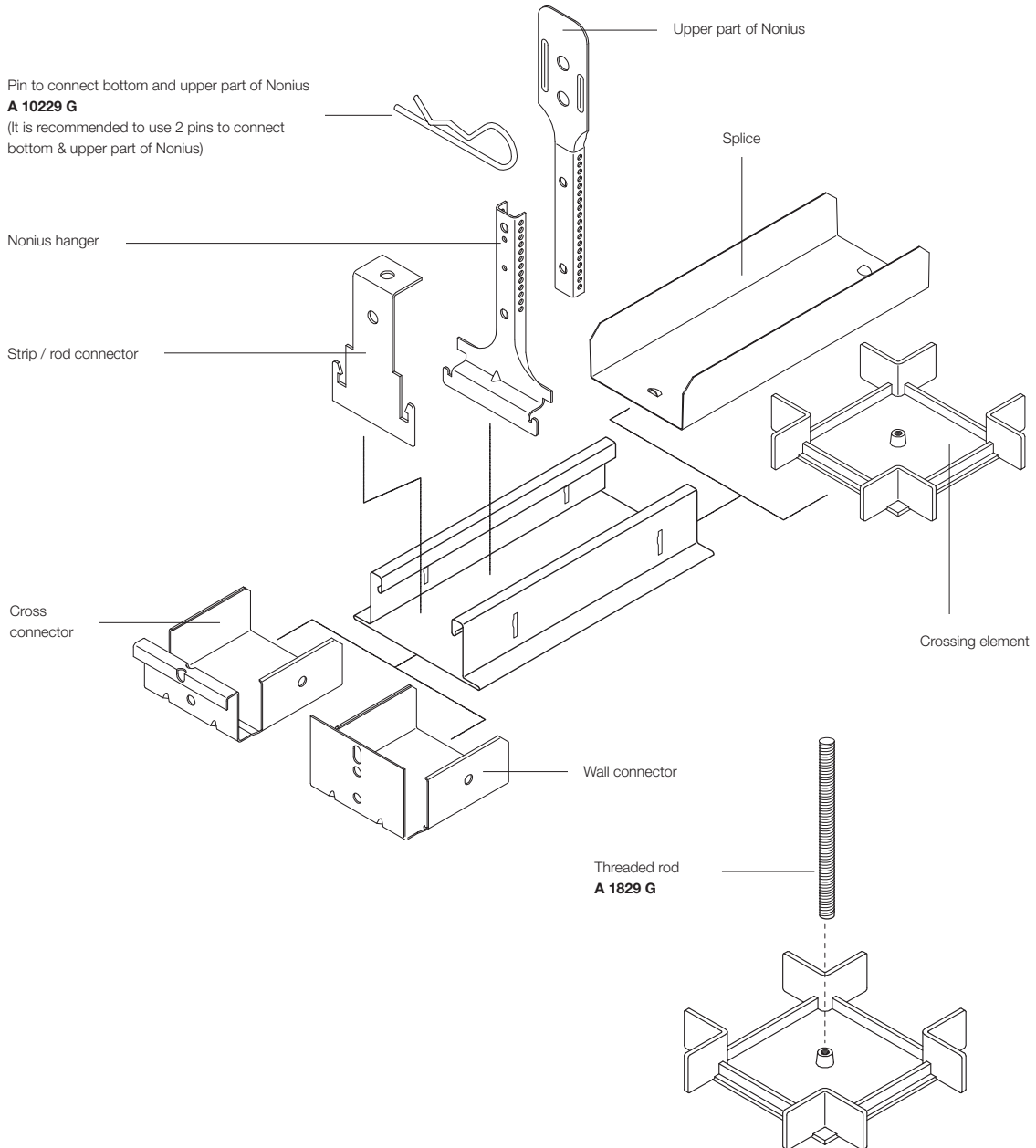

Availability of products may vary according to location.
Please contact our **Armstrong Technical Sales** for further details.

CENTRAL EUROPE SOUTH
(AL/BA/BG/CZ/HR/HU/KO/MD/ME/MK/RO/RS/SK/SI)
Armstrong Building Products
Lighthouse Building
Jankovcova 1569/2c
170 00 Praha 7
Czech Republic
Tel. : +420 234 700 543
e-mail : service-ce@armstrong.com

Czech Republic : www.armstrong.cz
Hungary : www.armstrong.co.hu
Romania : www.armstrong.ro
Serbia : www.armstrong.rs
Slovakia : www.armstrong.sk
Slovenia : www.armstrong.si

www.armstrong.eu

